



## MMA Hydraulic Cylinders

'Mill Type' roundline cylinders for working pressures up to 250 bar

aerospace  
climate control  
electromechanical  
filtration  
fluid & gas handling  
**hydraulics**  
pneumatics  
process control  
sealing & shielding



ENGINEERING YOUR SUCCESS.

**Contents**

Design Features and Benefits	3
Seal Options	4
Optional Features	5
Servicing Features	5
Mounting Information	5
Cylinder Masses	5, 15
Dimensions – Round Flange Mountings	6
Dimensions – Pivot Mountings	7
Dimensions – Trunnion and Foot Mountings	8-9
Rod End Accessories	9
Dimensions – Piston Rod Ends	10
Push and Pull Forces	11
Piston Rod Size Selection	12
Long Stroke Cylinders	12
Stop Tubes	13
Stroke Factors	13
Cushioning	14-15
Ports	16
Replacement Parts and Service	17-18
How to Order Cylinders	19
Port, Air Bleed and Cushion Adjustment Locations	19

**Introduction**

The heavy duty series MMA cylinder has been designed for service in steel mills and in other arduous applications where a rugged, dependable cylinder is required. In addition to the standard cylinders featured in this catalogue, MMA cylinders can be designed and manufactured to suit individual customer requirements.

**Standard Specifications**

- Heavy Duty construction
  - Styles and dimensions to: CETOP RP73H, ISO 6022\*, DIN 24 333, BS 6331 Pt. III, AFNOR NF E48-025, VW 39D 921
  - Rated pressure: 250 bar
  - Fatigue-free at the rated pressure
  - Hydraulic mineral oil – other fluids on request
  - Temperature range of standard seals: -20°C to +80°C
  - Construction: head & cap bolted to heavy steel flanges
  - Bore sizes: 50mm to 320mm
  - Piston rod diameters: 32mm to 220mm
  - Cushioning – optional at both ends
  - Air bleeds – optional at both ends
  - Tested in accordance with ISO 10100 : 2001
- \* 140mm and 180mm bore cylinders do not conform to ISO 6022

**Parker Offers the Widest Range of Industrial Cylinders**

**High Productivity – Low Cost of Ownership**

Parker Hannifin's Cylinder Division is the world's largest supplier of hydraulic cylinders for industrial applications.

Parker manufactures a vast range of standard and special tie rod, roundline and 'mill' type cylinders to suit all types of industrial cylinder applications. Our cylinders are available to ISO, DIN, NFPA, ANSI and JIC standards, with other certifications available on request. All Parker hydraulic cylinders are designed to deliver long, efficient service with low maintenance requirements, guaranteeing high productivity year after year.

**inPHorm**

For accurate sizing of MMA hydraulic cylinders, please contact your nearest Parker Sales office and ask for the European cylinder inPHorm selection programme HY07-1260/Eur.

**About Parker Hannifin**

Parker Hannifin is the global leader in motion and control technologies, partnering with its customers to increase their productivity and profitability. The company employs more than 61,000 people in 48 countries around the world, providing customers with technical excellence and first class customer service.

**Visit us at [www.parker.com](http://www.parker.com)**

**Warning**

FAILURE OR IMPROPER SELECTION OR IMPROPER USE OF THE PRODUCTS AND/OR SYSTEMS DESCRIBED HEREIN OR RELATED ITEMS CAN CAUSE DEATH, PERSONAL INJURY AND PROPERTY DAMAGE.

This document and other information from Parker Hannifin Corporation, its subsidiaries, sales offices and authorized distributors provide product or system options for further investigation by users having technical expertise. Before you select or use any product or system it is important that you analyse all aspects of your application and review the information concerning the product or system in the current product catalogue. Due to the variety of operating conditions and applications for these products or systems, the user, through his own analysis and testing, is solely responsible for making the final selection of the products and systems and assuring that all performance and safety requirements of the application are met.

The products described herein, including without limitation, product features, specifications, designs, availability and pricing, are subject to change by Parker Hannifin Corporation and its subsidiaries at any time without notice.

**Offer of Sale**

Please contact you local Parker representative for a detailed offer of sale.

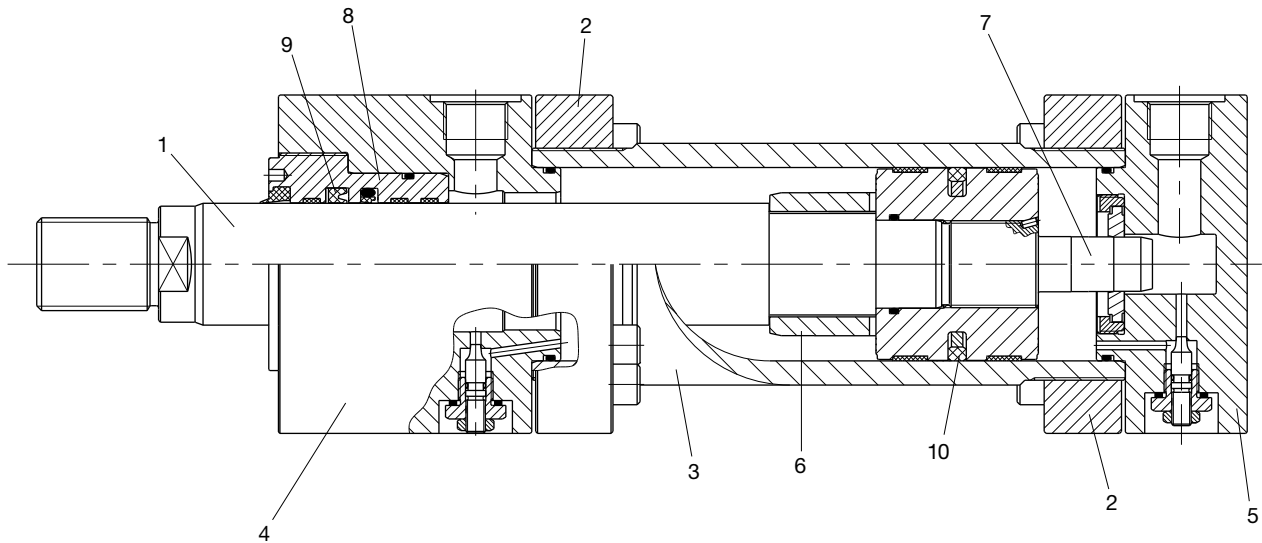

**1 Piston Rod**

Manufactured from precision ground, high tensile carbon alloy steel, hard chrome plated and polished to 0.2µm max. Piston rods up to 110mm in diameter are induction case hardened to Rockwell C54 minimum before chrome plating. This provides a 'dent resistant' surface, resulting in improved seal life. Piston rods of 125mm diameter and above can be case hardened on request. All rod and piston assemblies are designed to be fatigue free at full rated pressure.

**2 Head and Cap Retention**

The head and cap are bolted to heavy steel flanges, which are retained by threads at each end of the cylinder body.

**3 Cylinder Body**

The heavy wall steel tubing is honed to a high surface finish, to minimise internal friction and prolong seal life.

**4 & 5 Head & Cap Ends**

These are machined from steel and located into the cylinder body's internal diameter for added strength and precise alignment. Both the head and cap are sealed by O-rings which, in turn, are protected by anti-extrusion rings.

**6 & 7 Cushioning**

Optional cushions at the head and cap are progressive in action, providing controlled deceleration which reduces noise and shock loading, and prolongs machine life. The head end cushion is a self-centring sleeve, while the polished cap end spear is an integral part of the piston rod. Needle valves are provided at both ends of the cylinder for precise cushion adjustment, and are retained so that they cannot be inadvertently removed.

Check valves at the head and cap ends of the cylinder minimize restriction to the start of a stroke, permitting full power and fast cycle times. The head end check valve is incorporated into the fully floating cushion sleeve, while the cap end employs a floating bronze cushion bush.

**8 Rod Gland and Bearings**

Seals are housed in a corrosion-resistant steel gland, featuring heavy duty polymer bearing rings to resist side loadings. Wide separation of these rings reduces bearing stresses, maximising the service life of the bearing. The rod gland may be screwed or bolted. On bore sizes up to 100mm the rod gland is screwed (illustrated above). On larger bore sizes the rod gland is bolted.

The polymer bearing rings, with the rod seals, are easily replaced on removal of the rod gland, and all components may be serviced without further disassembly of the cylinder.

**9 & 10 Gland and Piston Seals**

A variety of gland and piston seal options is available, to suit different applications, as shown on page 4. In addition, MMA cylinders can be designed and manufactured to suit individual customer requirements. Please contact the factory for details.

The gland seals provide efficient retention of pressurized fluid while preventing the ingress of contaminants.

**Air Bleeds**

Available as an option at both ends, air bleeds are recessed into the head and cap and retained so they cannot be inadvertently removed. The air bleed location, in relation to the supply port location, must be specified on the order – see page 19.

**Gland Drains**

The tendency of hydraulic fluid to adhere to the piston rod can result in an accumulation of fluid in the cavity between the seals under certain operating conditions. This may occur with long stroke cylinders, where there is a constant back pressure as in differential circuitry, or where the ratio of the extend speed to the retract speed is greater than 2 to 1.

Gland drains should be piped back to the fluid reservoir, which should be located below the level of the cylinder.

**Gland and Piston Seal Options**

See Illustrations, page 17

**Standard Seals**

These are general purpose seals designed for a wide range of applications. They are suitable for use with Group 1 fluids and may be used for piston speeds up to 0.5m/s.

Standard gland seals employ a polyurethane lipseal and a PTFE stepped seal. The piston is fitted with a heavy duty filled polymer seal, and heavy duty wear rings which prevent contact between the piston and cylinder bore, protecting the piston seal from contaminants.

**Low Friction Option**

Low friction seals are suitable for applications where very low friction and an absence of stick-slip are important. They are not suitable for holding loads in a fixed position. Low friction seals are available for use with all fluid groups and are suitable for piston speeds up to 1m/s.

Low Friction gland seals comprise two low friction PTFE stepped seals and a heavy duty wiperseal, while the pistons employ a PTFE seal and PTFE wear rings.

**Chevron Option**

Chevron seals are designed for arduous applications, such as steel mills. They are suitable for holding a load in position. Chevron seals are available for use with all fluid groups, at piston speeds up to 0.5m/s.

Chevron gland seals have a corrosion-resistant steel retainer, and a separate removable steel housing which retains the inner bearing rings. A heavy duty wiper seal prevents the ingress of contaminants. Chevron pistons feature a two-piece piston with a wide bearing ring mounted between chevron seals.

**Load Holding Option**

Suitable for applications where loads are required to be held in position, the Load Holding option combines Standard gland seals, which have lower friction than the chevron equivalent, with chevron piston seals. They are suitable for use with Group 1 fluids and may be used for piston speeds up to 0.5m/s.

**Special Seals**

A range of seal options is available for the fluid groups listed below – see cylinder model numbers on page 19. Where required, special seals, in addition to those shown above, can also be supplied. Please insert an S (Special) in the model number and specify fluid medium when ordering.

**Group 6 Seal Life**

Seal life is reduced with High Water Content Fluids (HFA) due to the poor lubricity of the operating medium. Note that seal life also declines as pressure increases.

**Water Service**

Special modifications are available for high water content fluids. These include a stainless steel piston rod, and plating of internal surfaces. When ordering, please specify the maximum operating pressure or load/speed conditions, as the stainless steel rod is of lower tensile strength than the standard material.

**Warranty**

Parker Hannifin warrants cylinders modified for water or high water content fluid service to be free of defects in materials or workmanship, but cannot accept responsibility for premature failure caused by excessive wear resulting from lack of lubricity, or where failure is caused by corrosion, electrolysis or mineral deposits within the cylinder.

**Filtration**

Fluid cleanliness should be in accordance with ISO 4406. The quality of filters should be in accordance with the appropriate ISO standards.

The rating of the filter media depends on the system components and the application. The minimum required should be class 19/15 to ISO 4406, which equates to 25µ (β10≥75) to ISO 4572.

**Seals and Fluid Data**

Fluid Group	Seal Materials – a combination of:	Fluid Medium to ISO 6743/4-1982	Piston & Gland Type	Temperature Range
1	Nitrile (NBR), PTFE, enhanced polyurethane (AU)	Mineral Oil HH, HL, HLP, HLP-D, HM, HV, MIL-H-5606 oil, air, nitrogen	All	-20°C to +80°C
2	Nitrile (NBR), PTFE	Water glycol (HFC)	Chevron and Low Friction	-20°C to +60°C
5	Fluorocarbon elastomer (FPM), PTFE	Fire resistant fluids based on phosphate esters (HFD-R) Also suitable for hydraulic oil at high temperatures or in hot environments. <b>Not suitable for use with Skydrol.</b> See fluid manufacturer's recommendations.	Chevron and Low Friction	-20°C to +150°C
6	Various compounds including nitrile, enhanced polyurethane, fluorocarbon elastomers and PTFE	Water Oil in water emulsion 95/5 (HFA)	Chevron and Low Friction	+5°C to +55°C
7		Water in oil emulsion 60/40 (HFB)	Chevron and Low Friction	+5°C to +60°C

**Position Switches and Feedback Devices**

Non-contacting position switches and linear position transducers of various types may be fitted to MMA series cylinders. Please contact the factory for further details.

**Double Rodded Cylinders**

MMA series cylinders are available with the option of a double-ended piston rod. Please contact the factory for further details.

**Rod End Bellows**

Exposed rod surfaces that are subjected to air hardening contaminants should be protected by rod end bellows. Longer rod extensions are required to accommodate their collapsed length – please consult the factory for details.

**Rod Material**

As an alternative to the normal piston rod material, stainless steel and other special materials and finishes can be supplied.

**Metallic Rod Wipers**

For applications where contaminants may adhere to the extended piston rod and thereby cause premature failure of gland seals, the use of a metallic rod wiper in place of the standard wiper seal is recommended.

**Special Designs**

Alternative sealing arrangements, special mounting styles, higher or lower rated pressure designs, welded cap ends to reduce overall length (non-cushioned only), larger bores and alternative rod sizes are just a few of the special requirements which can be accommodated by our design and engineering staff.

**Marine Environments**

MMA cylinders can be supplied with modifications to material and paint specifications which make them suitable for operation in a marine environment. Please consult the factory.

**Servicing Features**

The MMA series has been designed to make maintenance as easy as possible, by incorporating the following design features:

**Removable Gland** – Rod bearing and rod seals can be replaced without completely dismantling the cylinder. For chevron glands, a thread is machined on the outside diameter of the seal housing to assist extraction.

**Chamfers** at both ends of the cylinder body ease assembly of the head and cap and insertion of the piston seals.

**Retaining flanges** are removable, allowing separate replacement of the cylinder body. Flanges are spaced from the head and cap to allow the bolts to be sawn through in the event of severe damage or corrosion.

**High tensile bolts** are used for ease of maintenance.

**Spherical Bearings**

All spherical bearings should be re-packed with grease periodically. In unusual or severe working conditions, consult the factory regarding the suitability of the bearing chosen.

**Mounting Bolts**

It is recommended that mounting bolts with a strength to ISO 898/1 grade 12.9 should be used for fixing cylinders to the machine or base. Mounting bolts should be torque loaded to their manufacturer's recommended figures.

**Trunnions**

On the 320mm bore cylinder the trunnion is welded to the cylinder body. On all other bore sizes the trunnion assembly is threaded to the cylinder body and secured with a locking ring. If a different arrangement is needed to suit a particular application, please consult the factory.

Trunnions require lubricated pillow blocks with minimum bearing clearances. Blocks should be mounted and aligned to eliminate bending moments on the trunnion pins.

**Head and Cap Retention Bolts**

The head and cap retention bolts on MMA Series cylinders are torque loaded on assembly in the factory. If damage or corrosion is found on removal, the old bolts must be discarded and replacement bolts with a minimum strength to ISO 898/1 grade 12.9 must be fitted. Head and cap bolts should always be tightened progressively in a diagonal sequence and torque loaded to the figures shown in the table.

Bore Ø	Flange Bolts	
	Torque Load (Nm)	Bolt Size
50	26-28	M8
63	51-54	M10
80	112-118	M12
100	157-165	M14
125	247-260	M16
140		
160	456-480	M20
180		
200	668-692	M22
250	1112-1170	M27
320	1425-1500	M33

**Cylinder Masses**

Where applicable, accessory masses can be added to give a gross mass – see page 9.

Bore Ø	Rod No.	Mounting Styles at Zero Stroke, in kg				per 10mm Stroke kg
		MF3 & MF4	MP3 & MP5	MT4	MS2	
50	1	14.8	16.2	16.6	16.6	0.2
	2	17.8	16.2	16.7	16.6	0.2
63	1	27	26	26	24	0.3
	2	27	26	26	24	0.3
80	1	39	37	37	35	0.5
	2	39	37	37	35	0.5
100	1	61	59	59	56	0.6
	2	61	59	59	56	0.7
125	1	103	103	105	95	0.9
	2	104	104	105	96	1.0
140	1	164	168	171	158	1.1
	2	164	168	171	158	1.2
160	1	198	205	204	188	1.6
	2	199	205	205	188	1.7
180	1	289	290	292	274	2.0
	2	289	291	293	275	2.2
200	1	356	377	363	335	2.2
	2	357	378	364	336	2.4
250	1	646	698	685	614	3.2
	2	647	700	687	616	3.6
320	1	1180	1294	1239	1116	5.1
	2	1230	1345	1290	1118	5.6

All dimensions are in millimetres unless otherwise stated.

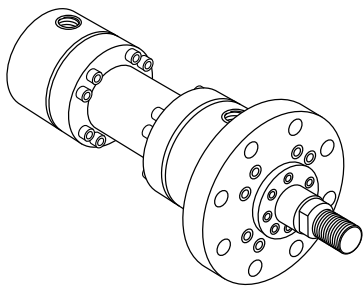

**Style MF3**  
Head Circular Flange

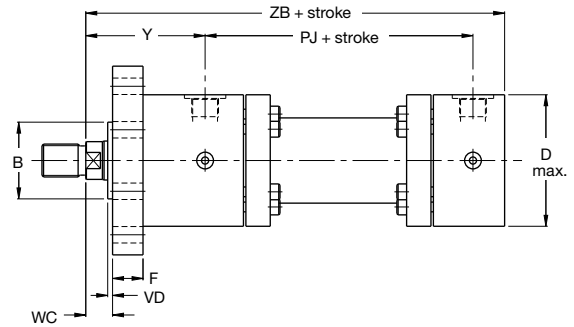
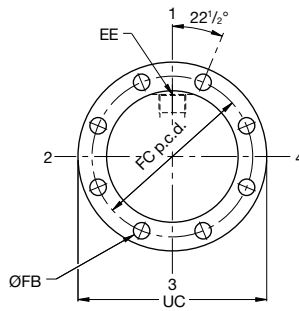

Accurate location of 'B' provided as standard on model MF3 only.

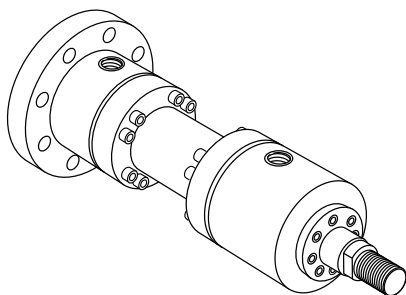

**Style MF4**  
Cap Circular Flange

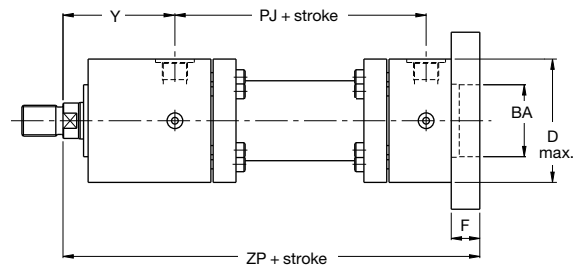
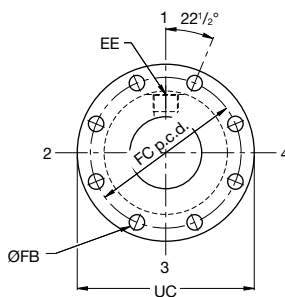

**Dimensions – MF3 and MF4** See also Rod End Dimensions, page 10

Bore Ø	Rod No.	MM Rod Ø	B <sup>fs</sup> & BA <sup>H8</sup>	D max.	EE (BSPP)	F	FB	FC	UC	VD min.	WC	Y	Min. Stroke	+ Stroke		
														PJ	ZB max.	ZP
50	1 2	32 36	63	108	G <sup>1</sup> / <sub>2</sub>	25	13.5	132	155	4	22	98	20	120	244	265
63	1 2	40 45	75	124	G <sup>3</sup> / <sub>4</sub>	28	13.5	150	175	4	25	112	30	133	274	298
80	1 2	50 56	90	148	G <sup>3</sup> / <sub>4</sub>	32	17.5	180	210	4	28	120	20	155	305	332
100	1 2	63 70	110	175	G1	36	22	212	250	5	32	134	25	171	340	371
125	1 2	80 90	132	208	G1	40	22	250	290	5	36	153	50	205	396	430
140 <sup>1</sup>	1 2	90 100	145	255	G <sup>1</sup> / <sub>4</sub>	40	26	300	340	5	36	181	50	208	430	465
160	1 2	100 110	160	270	G <sup>1</sup> / <sub>4</sub>	45	26	315	360	5	40	185	50	235	467	505
180 <sup>1</sup>	1 2	110 125	185	315	G <sup>1</sup> / <sub>4</sub>	50	33	365	420	5	45	205	20	250	505	550
200	1 2	125 140	200	330	G <sup>1</sup> / <sub>4</sub>	56	33	385	440	5	45	220	20	278	550	596
250	1 2	160 180	250	412	G <sup>1</sup> / <sub>2</sub>	63	39	475	540	8	50	260	20	325	652	703
320	1 2	200 220	320	510	G2	80	45	600	675	8	56	310	20	350	764	830

<sup>1</sup> 140mm and 180mm bore cylinders do not conform to ISO 6022.

All dimensions are in millimetres unless otherwise stated.



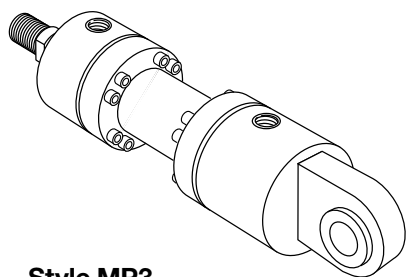

**Style MP3**  
 Cap Fixed Eye

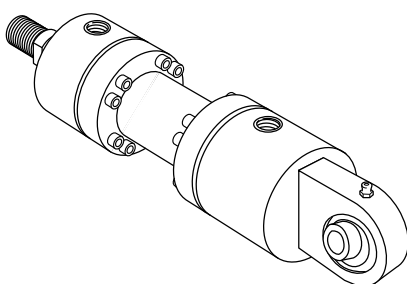
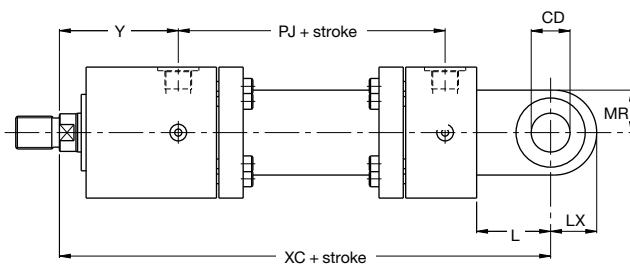
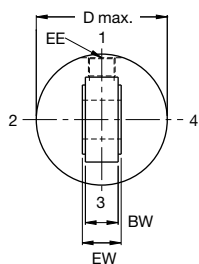

**Style MP5**  
 Cap Fixed Eye  
 with Spherical Bearing

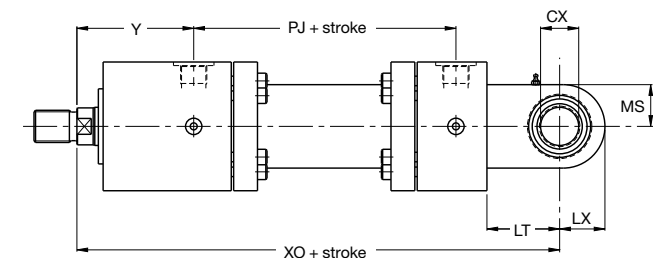
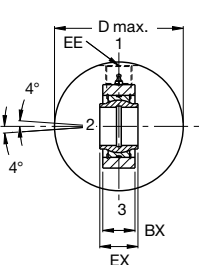

**Dimensions – MP3 and MP5** See also Rod End Dimensions, page 10

Bore Ø	Rod No.	MM Rod Ø	BW & BX	CD <sup>H9</sup> & CX <sup>H7</sup>	D max.	EE (BSPP)	EW <sup>h12</sup> & EX <sup>h12</sup>	L & LT	LX	MR & MS	Y	Min. Stroke	+ Stroke	
													PJ	XC & XO
50	1 2	32 36	27	32	108	G <sup>1</sup> / <sub>2</sub>	32	61	38	35	98	20	120	305
63	1 2	40 45	35	40	124	G <sup>3</sup> / <sub>4</sub>	40	74	50	50	112	30	133	348
80	1 2	50 56	40	50	148	G <sup>3</sup> / <sub>4</sub>	50	90	61.5	61.5	120	20	155	395
100	1 2	63 70	52	63	175	G1	63	102	71	66	134	25	171	442
125	1 2	80 90	60	80	208	G1	80	124	90	90	153	50	205	520
140 <sup>1</sup>	1 2	90 100	65	90	255	G <sup>1</sup> / <sub>4</sub>	90	150	113	113	181	50	208	580
160	1 2	100 110	84	100	270	G <sup>1</sup> / <sub>4</sub>	100	150	112	112	185	50	235	617
180 <sup>1</sup>	1 2	110 125	88	110	315	G <sup>1</sup> / <sub>4</sub>	110	185	129	118	205	20	250	690
200	1 2	125 140	102	125	330	G <sup>1</sup> / <sub>4</sub>	125	206	145	131	220	20	278	756
250	1 2	160 180	130	160	412	G <sup>1</sup> / <sub>2</sub>	160	251	178	163	260	20	325	903
320	1 2	200 220	162	200	510	G2	200	316	230	209	310	20	350	1080

<sup>1</sup> 140mm and 180mm bore cylinders do not conform to ISO 6022.

All dimensions are in millimetres unless otherwise stated.

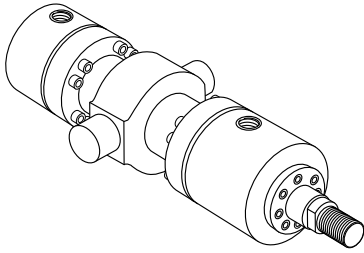

**Style MT4**  
Intermediate Trunnion

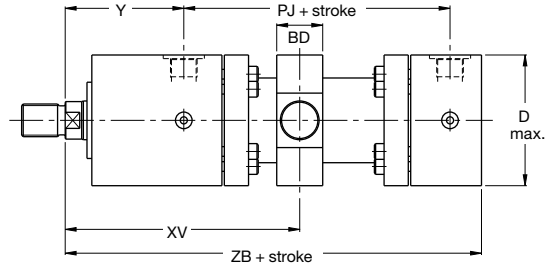
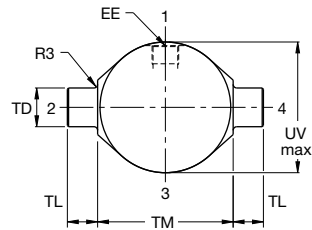

**Note:** XV Dimension to be specified by customer. Where minimum dimension is unacceptable, please consult factory.

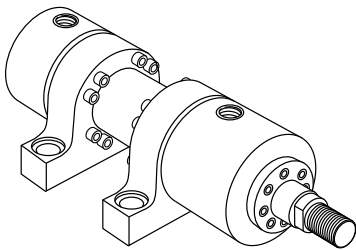

**Style MS2**  
Foot Mounting  
(Not to ISO 6022)

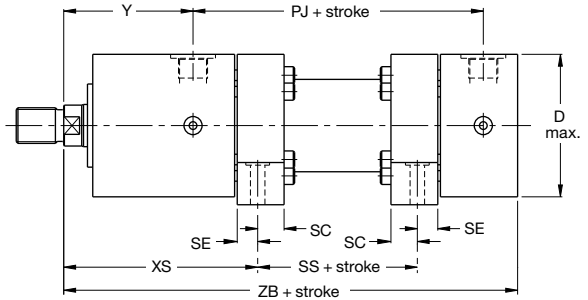
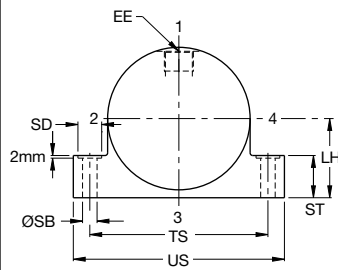

**Note:** The MS2 mounting should only be used where the stroke is at least half of the bore diameter or where the cylinder operates below 160 bar.

**Dimensions – MT4** See also Rod End Dimensions, page 10

Bore Ø	Rod No.	MM Rod Ø	BD	D max.	EE (BSPP)	TD <sup>16</sup>	TL	TM <sup>h13</sup>	UV max.	XV min.	Y	Min. Stroke	+ Stroke		
													PJ	XV max.	ZB max.
50	1 2	32 36	38	108	G <sup>1</sup> / <sub>2</sub>	32	25	112	108	187	98	55	120	132	244
63	1 2	40 45	48	124	G <sup>3</sup> / <sub>4</sub>	40	32	125	124	212	112	75	133	137	274
80	1 2	50 56	58	148	G <sup>3</sup> / <sub>4</sub>	50	40	150	148	245	120	90	155	155	305
100	1 2	63 70	73	175	G1	63	50	180	175	280	134	120	171	160	340
125	1 2	80 90	88	208	G1	80	63	224	218	340	153	160	205	180	396
140 <sup>1</sup>	1 2	90 100	98	255	G1 <sup>1</sup> / <sub>4</sub>	90	70	265	260	380	181	180	208	200	430
160	1 2	100 110	108	270	G1 <sup>1</sup> / <sub>4</sub>	100	80	280	280	400	185	180	235	220	467
180 <sup>1</sup>	1 2	110 125	118	315	G1 <sup>1</sup> / <sub>4</sub>	110	90	320	315	410	205	170	250	240	505
200	1 2	125 140	133	330	G1 <sup>1</sup> / <sub>4</sub>	125	100	335	330	450	220	190	278	260	550
250	1 2	160 180	180	412	G1 <sup>1</sup> / <sub>2</sub>	160	125	425	412	540	260	240	325	300	652
320	1 2	200 220	220	510	G2	200	160	530	510	625	310	300	350	325	764

<sup>1</sup> 140mm and 180mm bore cylinders do not conform to ISO 6022.

All dimensions are in millimetres unless otherwise stated.





**Dimensions – MS2** See also Rod End Dimensions, page 10

Bore Ø	Rod No.	MM Rod Ø	D max.	EE (BSPP)	LH <sup>h10</sup>	SB <sup>H13</sup>	SC	SD	SE	ST	TS	US	XS	Y	Min. Stroke	+ Stroke		
																PJ	SS	ZB max.
50	1 2	32 36	108	G1/2	60	11	20.5 <sup>2</sup>	18	15.5	32	135	160	130.0	98	0	120	55	244
63	1 2	40 45	124	G3/4	68	13.5	24.5 <sup>2</sup>	20	17.5	37	155	185	147.5	112	20	133	55	274
80	1 2	50 56	148	G3/4	80	17.5	22.5	26	22.5	42	185	225	170.5	120	35	155	55	305
100	1 2	63 70	175	G1	95	22	27.5	33	27.5	52	220	265	192.5	134	55	171	55	340
125	1 2	80 90	208	G1	115	26	30.0	40	30.0	62	270	325	230.0	153	65	205	60	396
140 <sup>1</sup>	1 2	90 100	255	G1 1/4	135	30	35.5	48	35.5	77	325	390	254.5	181	80	208	61	430
160	1 2	100 110	270	G1 1/4	145	33	37.5	48	37.5	77	340	405	265.5	185	80	235	79	467
180 <sup>1</sup>	1 2	110 125	315	G1 1/4	165	40	42.5	60	42.5	87	390	465	287.5	205	70	250	85	505
200	1 2	125 140	330	G1 1/4	170	40	47.0 <sup>2</sup>	60	45.0	87	405	480	315.0	220	60	278	90	550
250	1 2	160 180	412	G1 1/2	215	52	52.0 <sup>2</sup>	76	50.0	112	520	620	360.0	260	60	325	120	652
320	1 2	200 220	510	G2	260	62	62.0 <sup>2</sup>	110	60.0	152	620	740	425.0	310	80	350	120	764

<sup>1</sup> 140mm and 180mm bore cylinders do not conform to ISO 6022

<sup>2</sup> Mounting holes offset from centre line

**Rod End Accessories**

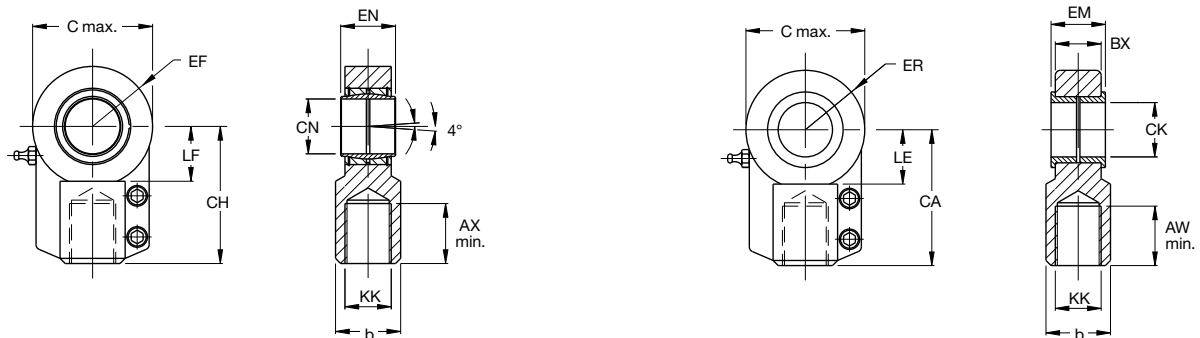

**Rod Eye with Spherical Bearing – ISO 6982**

**Rod Eye with Plain Bearing – ISO 6981**

**Dimensions**

Bore Ø	KK	Part No. – Rod Eye with:		AX & AW min.	CN <sup>H7</sup> & CK <sup>H9</sup>	EN <sup>h12</sup> & EM <sup>h12</sup>	CH & CA	LF & LE	C max.	EF & ER	BX	b	Torque Load Nm	Mass kg
		Spherical Bearing	Plain Bearing											
50	M27x2	145241	148731	37	32	32	80	32	76	40	27	38	32	1.2
63	M33x2	145242	148732	46	40	40	97	41	97	50	32	47	32	2.1
80	M42x2	145243	148733	57	50	50	120	50	118	63	40	58	64	4.4
100	M48x2	145244	148734	64	63	63	140	62	142	71	52	70	80	7.6
125	M64x3	145245	148735	86	80	80	180	78	180	90	66	90	195	14.5
140	M72x3	148723	148736	91	90	90	195	85	185	101	72	100	195	17
160	M80x3	148724	148737	96	100	100	210	98	224	112	84	110	385	28
180	M90x3	148725	148738	106	110	110	235	105	235	129	88	125	385	32
200	M100x3	148726	148739	113	125	125	260	120	290	160	103	135	385	43
250	M125x4	148727	148740	126	160	160	310	150	346	200	130	165	660	80
320	M160x4	148728	148741	161	200	200	390	195	460	250	162	215	1350	165

All dimensions are in millimetres unless otherwise stated.

**Rod End Style 4**

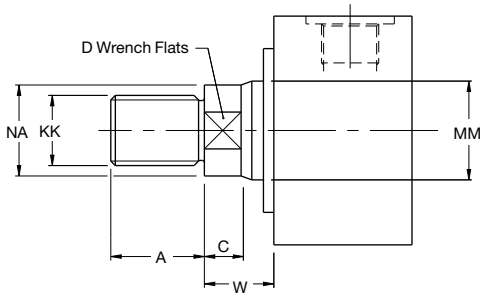

**Rod End Style 9**

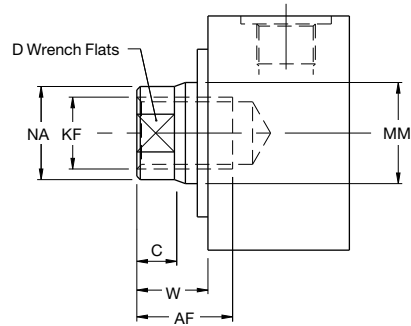

**Piston Rod End Styles**

MMA cylinders are available with standard metric male and female rod ends to ISO 4395. They can also be supplied with other rod end threads, eg: ISO metric coarse, Unified, British Standard etc., or to the customer's special requirements.

Style 4 denotes a standard male thread. Style 9 denotes a female thread, and is available only with the No.2 rod. Orders for non-standard rod ends, designated Style 3, should include dimensioned sketches and descriptions, showing dimensions KK or KF, A or AF, and the thread form required.

**Wrench Flats**

Piston rods up to and including 90mm in diameter are supplied with the wrench flats D shown in the table below. Rods above 90mm in diameter feature four drilled holes to accept a pin wrench.

**Rod End Dimensions** See also Cylinder Dimensions, pages 6-9

Bore Ø	Rod No.	MM Rod Ø	A & AF	C	D	NA	KK Style 4	KF Style 9	W
50	1 2	32 36	36	15	28 32	31 35	M27x2	- M27x2	22
63	1 2	40 45	45	18	34 36	38 43	M33x2	- M33x2	25
80	1 2	50 56	56	20	43 46	48 54	M42x2	- M42x2	28
100	1 2	63 70	63	23	53 60	60 67	M48x2	- M48x2	32
125	1 2	80 90	85	27	65 75	77 87	M64x3	- M64x3	36.5
140	1 2	90 100	90	27	75 -	87 96	M72x3	- M72x3	36.5
160	1 2	100 110	95	31	- -	96 106	M80x3	- M80x3	40.5
180	1 2	110 125	105	36	- -	106 121	M90x3	- M90x3	45.5
200	1 2	125 140	112	36	- -	121 136	M100x3	- M100x3	45.5
250	1 2	160 180	125	38	- -	155 175	M125x4	- M125x4	50.5
320	1 2	200 220	160	44	- -	195 214	M160x4	- M160x4	56.5

All dimensions are in millimetres unless otherwise stated.

### Calculation of Cylinder Diameter

If the piston rod is in compression, use the 'Push Force' table.

1. Identify the operating pressure closest to that required.
2. In the same column, identify the force required to move the load (always rounding up).
3. In the same row, look along to the cylinder bore required.

If the cylinder envelope dimensions are too large, increase the operating pressure, if possible, and repeat the exercise.

### Push Force

Bore Ø	Cylinder Bore Area mm <sup>2</sup>	Cylinder Push Force in kN				
		50 bar	100 bar	150 bar	200 bar	250 bar
50	1964	10	20	30	40	50
63	3117	15	31	46	63	79
80	5026	25	51	76	102	128
100	7854	40	80	120	160	200
125	12272	62	125	187	250	312
140	15386	77	154	231	308	385
160	20106	102	205	307	410	512
180	25434	127	254	381	508	635
200	31416	160	320	480	640	801
250	49087	250	500	750	1000	1250
320	80425	410	820	1230	1640	2050

### inPHorm

For more comprehensive information on the calculation of cylinder bore size required, please refer to the European cylinder inPHorm selection programme HY07-1260/Eur.

If the piston rod is in tension, use the 'Deduction for Pull Force' table. To determine the pull force:

1. Follow the procedure for 'Push' applications, as described.
2. Using the 'Deduction for Pull Force' table below, establish the force indicated according to the rod diameter and pressure selected.
3. Deduct this from the original 'Push' force. The resulting figure is the net force available to move the load.

If this force is not large enough, repeat the process again but increase the system operating pressure or cylinder diameter if possible. If in doubt, please contact our design engineers.

### Deduction for Pull Force

Piston Rod Ø	Piston Rod Area mm <sup>2</sup>	Reduction in Cylinder Push Force in kN due to Area of Piston rod				
		50 bar	100 bar	150 bar	200 bar	250 bar
32	804	4	8	12	16	20
36	1018	5	10	15	20	25
40	1257	6	12	19	24	31
45	1590	8	16	24	32	40
50	1964	10	19	29	38	49
56	2463	12	25	37	50	62
63	3386	17	34	51	68	85
70	3848	19	39	58	78	98
80	5027	25	50	76	100	126
90	6362	32	64	97	129	162
100	7855	39	79	118	158	196
110	9503	48	96	145	193	242
125	12274	61	123	184	246	307
140	15394	78	156	235	313	392
160	20109	100	201	301	402	503
180	25447	129	259	389	518	648
200	31420	157	314	471	628	785
220	38013	198	387	581	775	969

**Piston Rod Size Selection**

1. Determine the type of cylinder mounting style and rod end connection to be used. Consult the Stroke Factor Selection table on page 13 and determine which factor corresponds to the application.

2. Using this stroke factor, determine the 'basic length' from the equation:

$$\text{Basic Length} = \text{Actual (net) Stroke} \times \text{Stroke Factor}$$

(The Piston Rod Selection Chart, below, applies to piston rods with standard rod extensions beyond the face of the gland retainer. For rod extensions greater than standard, add the increase to the stroke to arrive at the 'basic length'.)

3. Find the load imposed for the thrust application by multiplying the full bore area of the cylinder by the system pressure, or by referring to the Push and Pull Force charts on page 11.

4. Using the Piston Rod Selection Chart, below, look along the values for 'basic length' and 'thrust' as found in 2. and 3. above, and note the point of intersection.

The correct piston rod size is read from the diagonally curved line labelled 'Rod Diameter' above the point of intersection.

**Long Stroke Cylinders**

When considering the use of long stroke cylinders, the piston rod should be of sufficient diameter to provide the necessary column strength.

For tension (pull) loads, the rod size is selected by specifying standard cylinders with standard rod diameters, and using them at or below the rated pressure.

For long stroke cylinders under compressive loads, the use of a stop tube should be considered, to reduce bearing stress.

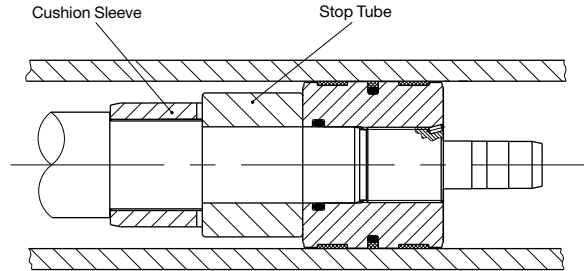

**Piston Rod Selection Chart**

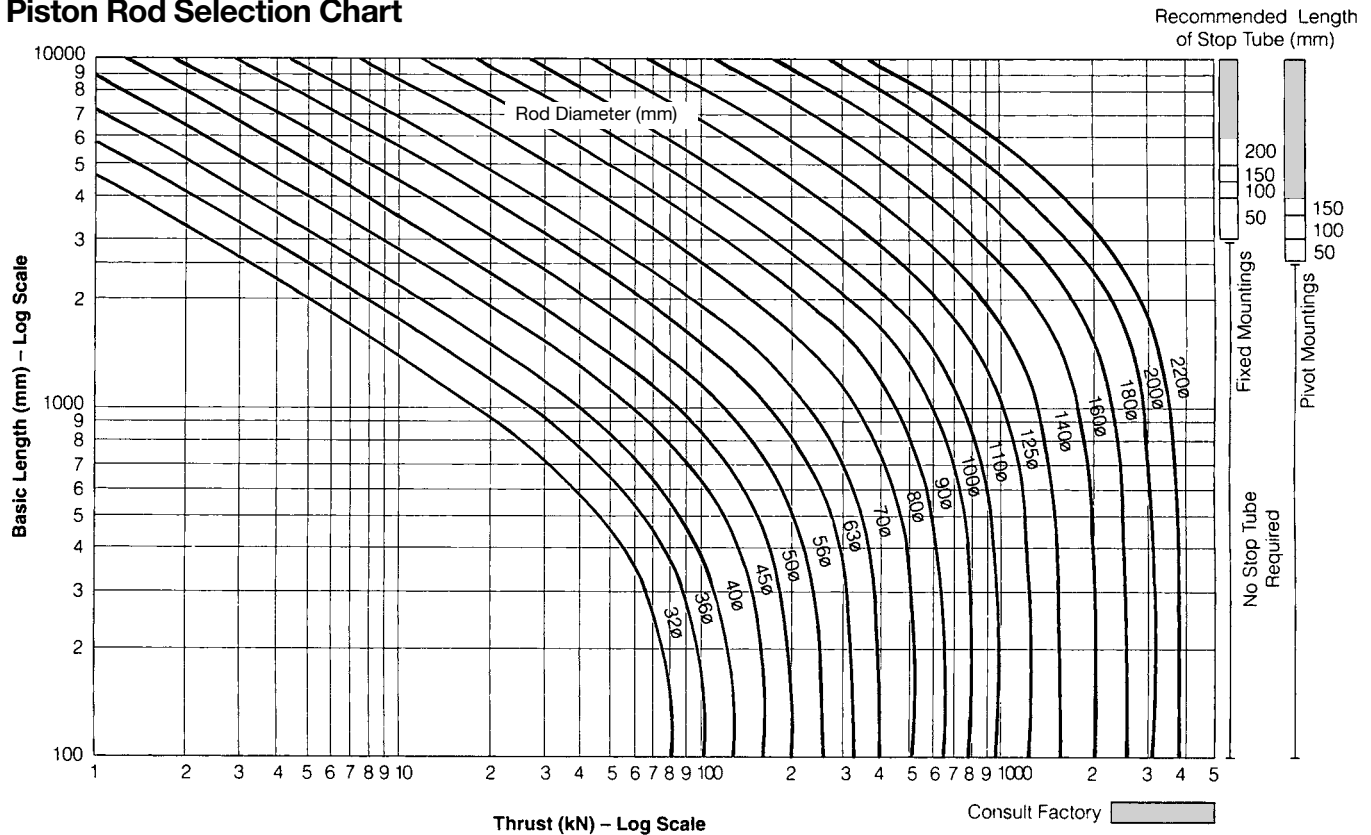

**Stop Tubes**

The Piston Rod Selection Chart indicates where the use of a stop tube should be considered. The required length of stop tube, where necessary, is read from the vertical columns on the right of the chart, by following the horizontal band within which the point of intersection lies. Note that stop tube requirements differ for fixed and pivot mounted cylinders.

If the required length of stop tube is in the shaded region marked 'consult factory', please submit the following information:

1. Cylinder mounting style.
2. Rod end connection and method of guiding load.
3. Bore and stroke required, and length of rod extension (Dimension 'W') if greater than standard.



4. Mounting position of cylinder. If at an angle or vertical, specify the direction of the piston rod.
5. Operating pressure of the cylinder if limited to less than the standard pressure for the cylinder selected.

When specifying a cylinder with a stop tube, please insert an 'S' (Special) and the **net** stroke of the cylinder in the order code, and state the length of the stop tube. Note that net stroke is equal to the gross stroke of the cylinder less the length of the stop tube. The gross stroke determines the envelope dimensions of the cylinder.

**inPHorm**

For accurate sizing, please refer to the European cylinder inPHorm selection programme HY07-1260/Eur.

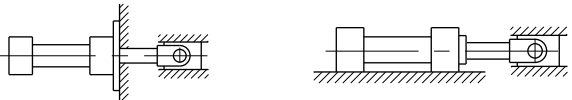
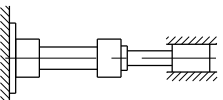
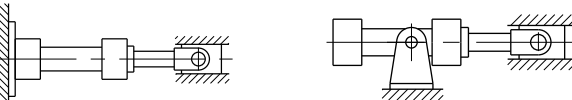
**Stroke Factor Selection**

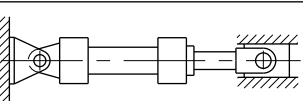
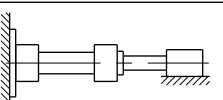
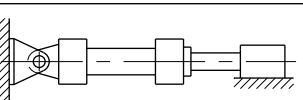
Rod End Connection	Style	Type of Mounting	Stroke Factor
Fixed and rigidly guided	MF3 MS2		0.5
Pivoted and rigidly guided	MF3 MS2		0.7
Fixed and rigidly guided	MF4		1.0
Pivoted and rigidly guided	MF4 MT4		1.5
Supported but not rigidly guided	MF3 MS2		2.0
Pivoted and rigidly guided	MP3 MP5		2.0
Supported but not rigidly guided	MF4		4.0
Supported but not rigidly guided	MP3 MP5		4.0

**An Introduction to Cushioning**

Cushioning is recommended as a means of controlling the deceleration of masses, or for applications where piston speeds are in excess of 0.1m/s and the piston will make a full stroke. Cushioning extends cylinder life and reduces undesirable noise and hydraulic shock.

Built-in deceleration devices or 'cushions' are optional and can be supplied at the head and cap ends of the cylinder without affecting its envelope or mounting dimensions. Cushions are adjustable via recessed needle valves.

**Standard Cushioning**

Ideal cushion performance shows an almost uniform absorption of energy along the cushion's length. Where specified, MMA cylinders use specially profiled cushions, giving a performance which comes close to the ideal in the majority of applications. The head and cap cushion performance for each bore size is illustrated on the charts on page 15.

**Alternative Forms of Cushioning**

Special designs can be produced to suit applications where the energy to be absorbed exceeds the performance of the standard cushion. Please consult the factory for details.

**Cushion Length**

All MMA cylinder cushions incorporate the longest cushion sleeve and spear that can be provided in the standard envelope without decreasing the rod bearing and piston bearing lengths – see table of cushion lengths on page 15.

**Cushion Calculations**

The charts on page 15 show the energy absorption capacity for each bore and rod combination at the head (annulus) and the cap (full bore) ends of the cylinder. The charts are valid for piston velocities in the range of 0.1–0.3m/s. For velocities between 0.3m/s–0.5m/s, the energy values from the charts should be reduced by 25%. For velocities of less than 0.1m/s where large masses are involved, and for velocities greater than 0.5m/s, a special cushion profile may be required. Please consult the factory.

The cushion capacity of the head end is less than that of the cap, owing to the pressure intensification effect across the piston.

The energy absorption capacity of the cushion decreases with drive pressure, which in normal circuits is the relief valve setting.

**inPHorm**

Cushioning requirements can be calculated automatically for individual cylinder/load combinations using the European cylinder inPHorm selection programme HY07-1260/Eur.

**Formulae**

Cushioning calculations are based on the formula:  $E = \frac{1}{2}mv^2$  for horizontal applications. For inclined or vertically downward or upward applications, this is modified to:

$E = \frac{1}{2}mv^2 + mgl \times 10^{-3} \times \sin\alpha$   
 – for inclined or vertically downward direction of mass;

$E = \frac{1}{2}mv^2 - mgl \times 10^{-3} \times \sin\alpha$   
 – for inclined or vertically upward direction of mass.

Where:

- E = energy absorbed in Joules
- g = acceleration due to gravity = 9.81m/s<sup>2</sup>
- v = velocity in metres/second
- l = length of cushion in millimetres (see page 15)
- m = mass of load in kilogrammes (including piston and rod, see page 15)
- $\alpha$  = angle to horizontal in degrees
- p = pressure in bar

**Example**

The following example shows how to calculate the energy developed by masses moving in a straight line. For non-linear motion, other calculations are required; please consult the factory. The example assumes that the bore and rod diameters are already appropriate for the application. The effects of friction on the cylinder and load have been ignored.

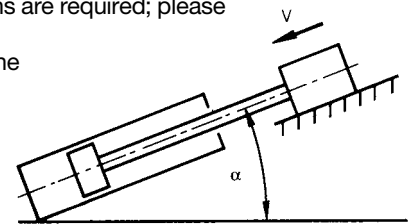

- Selected bore/rod = 80/50mm (No.1 rod)
- Cushioning at the cap end
- Pressure = 150 bar
- Mass = 7710 kg
- Velocity = 0.4m/s
- $\alpha$  = 45°
- Sin $\alpha$  = 0.7
- Cushion length = 45mm

$E = \frac{1}{2}mv^2 + mgl \times 10^{-3} \times \sin\alpha$

$E = \frac{7710 \times 0.4^2}{2} + 7710 \times 9.81 \times \frac{45}{10^3} \times 0.7$

$E = 617 + 2383 = 3000 \text{ Joules}$

**Note:** as velocity is greater than 0.3m/s, the energy absorption figures obtained from the charts on page 15 should be reduced by 25% – see Cushion Calculations, opposite. Comparison with the cushioning chart curve for this cylinder shows an energy capacity for the cap end cushion of 5100 Joules. Reducing this by 25% gives a capacity of 3825 Joules, so the standard cushion can safely decelerate the 3000 Joules in this example.

Where cushion performance figures are critical, our engineers can run a computer simulation to determine accurate cushion performance – please contact the factory for details.

**Cushion Energy Absorption Data**

The cushion energy absorption capacity data shown below are based on the maximum fatigue-free pressures developed in the cylinder tube. If working life cycle applications of less than 10<sup>6</sup>

cycles are envisaged, then greater energy absorption figures can be applied. Please consult the factory if further information is required.

**Head End, No.1 Rod**

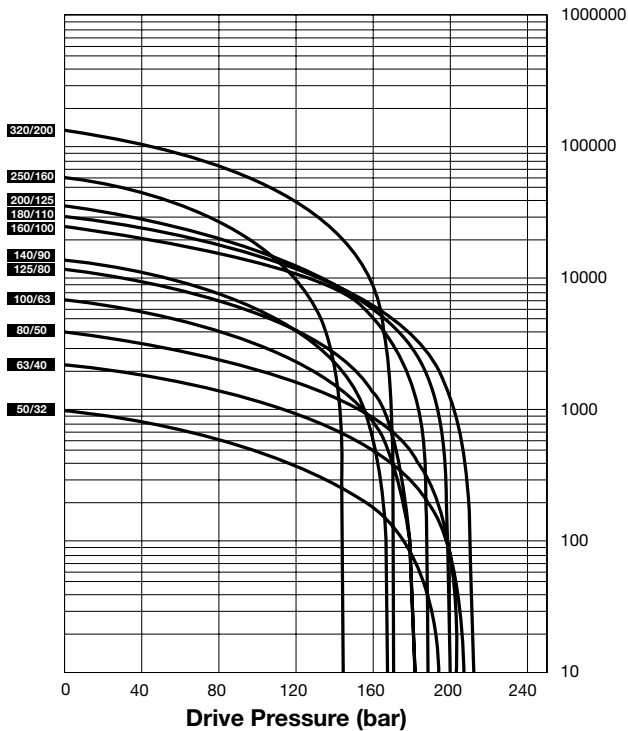

**Head End, No.2 Rod**

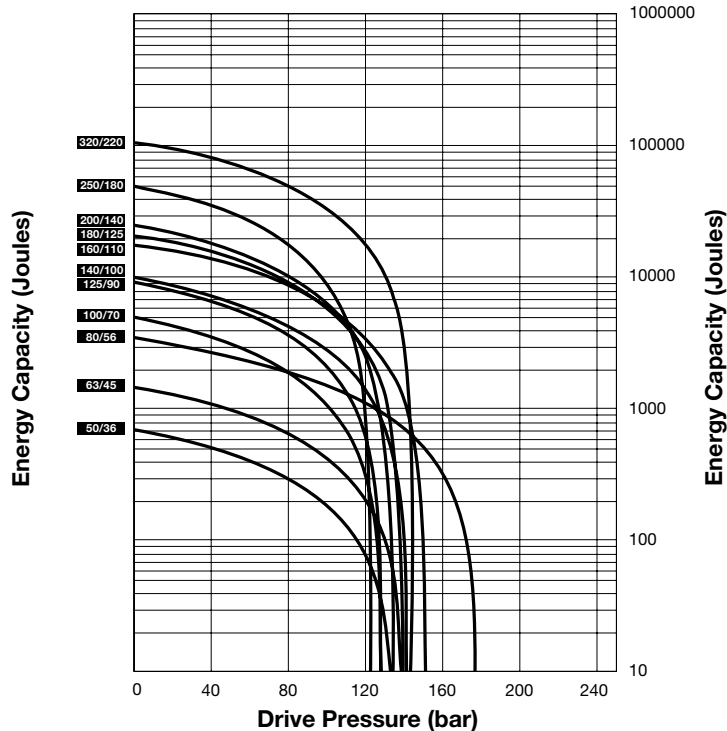

**Cap End, No.1 and No.2 Rods**

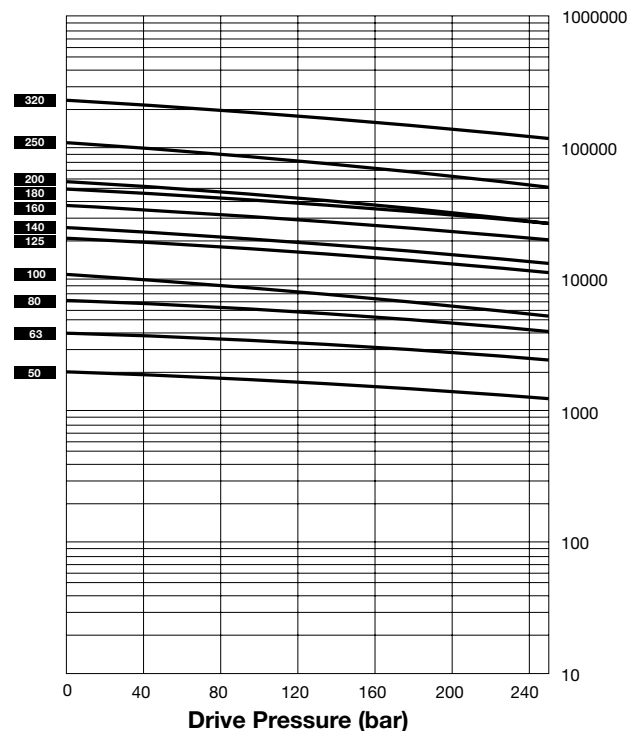

**Cushion Length, Piston & Rod Mass**

Bore Ø	Rod No.	Rod Ø	Cushion Length	Piston & Rod Zero stroke kg	Rod per 10mm Stroke kg
50	1	32	30	2.0	0.06
	2	36		2.3	0.08
63	1	40	40	3.4	0.10
	2	45		4.0	0.12
80	1	50	45	5.8	0.15
	2	56		6.7	0.19
100	1	63	55	10.7	0.24
	2	70		12.1	0.30
125	1	80	60	20.7	0.39
	2	90		23.8	0.50
140	1	90	60	28.0	0.50
	2	100		31.0	0.62
160	1	100	65	40.1	0.62
	2	110		44.6	0.75
180	1	110	65	54.0	0.75
	2	125		62.0	0.96
200	1	125	65	76.2	0.96
	2	140		86.0	1.23
250	1	160	90	131.8	1058
	2	180		150.2	2.00
320	1	200	100	250.2	2.46
	2	220		279.7	2.98

All dimensions are in millimetres unless otherwise stated.

**Port Size and Piston Speed**

Fluid velocity in connecting lines should be limited to 5m/s to minimise fluid turbulence, pressure loss and 'water hammer' effects. The tables below show piston speeds for standard and oversize ports and connecting lines where the velocity of fluid is 5m/s. If the desired piston speed results in a fluid flow in excess of 5m/s in connecting lines, larger lines with two ports per cap should be considered. Parker recommends that a flow rate of 12m/s in connecting lines should not be exceeded.

Bore Ø	Standard Cylinder Port			
	Port Size (BSPP)	Bore of Connecting Lines	Cap End Flow in l/min at 5m/s <sup>1</sup>	Piston Speed m/s
50	G <sup>1</sup> / <sub>2</sub>	13	40	0.34
63	G <sup>3</sup> / <sub>4</sub>	15	53	0.28
80	G <sup>3</sup> / <sub>4</sub>	15	53	0.18
100	G1	19	85	0.18
125	G1	19	85	0.12
140	G1 <sup>1</sup> / <sub>4</sub>	22	114	0.12
160	G1 <sup>1</sup> / <sub>4</sub>	22	114	0.10
180	G1 <sup>1</sup> / <sub>4</sub>	22	114	0.08
200	G1 <sup>1</sup> / <sub>4</sub>	22	114	0.06
250	G1 <sup>1</sup> / <sub>2</sub>	28	185	0.06
320	G2	38	340	0.07

Bore Ø	Oversize Cylinder Port			
	Port Size (BSPP)	Bore of Connecting Lines	Cap End Flow in l/min at 5m/s <sup>1</sup>	Piston Speed m/s
50	G <sup>3</sup> / <sub>4</sub>	14	53	0.45
63	G1	19	85	0.46
80	G1	19	85	0.28
100	G1 <sup>1</sup> / <sub>4</sub>	22	114	0.24
125	G1 <sup>1</sup> / <sub>4</sub>	22	114	0.16
140	G1 <sup>1</sup> / <sub>2</sub>	28	185	0.20
160	G1 <sup>1</sup> / <sub>2</sub>	28	185	0.15
180	G1 <sup>1</sup> / <sub>2</sub>	28	185	0.12
200	G1 <sup>1</sup> / <sub>2</sub>	28	185	0.10
250	G2	38	340	0.12
320	-	-	-	-

<sup>1</sup> This refers to fluid velocity in connecting lines, not piston velocity

**Flange Port Sizes**

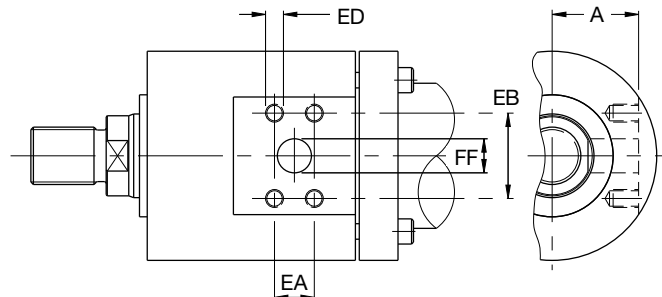

All dimensions are in millimetres unless otherwise stated.

**Port Types**

In addition to the standard and oversize BSPP ports, metric threaded ports to DIN 3852 Pt. 1 and ISO 6149, and flange ports to ISO 6162 can also be supplied – see tables below. The ISO 6149 port incorporates a raised ring in the spot face for identification. Other flange port styles are available on request.

Bore Ø	Standard Port			Oversize Port		
	BSPP	Metric	DN Flange	BSPP	Metric	DN Flange
50	G <sup>1</sup> / <sub>2</sub>	M22x1.5	13	G <sup>3</sup> / <sub>4</sub>	M27x2	*
63	G <sup>3</sup> / <sub>4</sub>	M27x2	13	G1	M33x2	*
80	G <sup>3</sup> / <sub>4</sub>	M27x2	13	G1	M33x2	19
100	G1	M33x2	19	G1 <sup>1</sup> / <sub>4</sub>	M42x2	25
125	G1	M33x2	19	G1 <sup>1</sup> / <sub>4</sub>	M42x2	25
140	G1 <sup>1</sup> / <sub>4</sub>	M42x2	25	G1 <sup>1</sup> / <sub>2</sub>	M48x2	32
160	G1 <sup>1</sup> / <sub>4</sub>	M42x2	25	G1 <sup>1</sup> / <sub>2</sub>	M48x2	32
180	G1 <sup>1</sup> / <sub>4</sub>	M42x2	25	G1 <sup>1</sup> / <sub>2</sub>	M48x2	32
200	G1 <sup>1</sup> / <sub>4</sub>	M42x2	25	G1 <sup>1</sup> / <sub>2</sub>	M48x2	32
250	G1 <sup>1</sup> / <sub>2</sub>	M48x2**	32	G2	M60x2	38
320	G2	M60x2	32	-	-	38

\* Consult factory

\*\* An M50 thread to DIN 24 333 can be supplied if required.

**Flange Port Sizes**

Bore Ø	Standard Flange Port					
	DN Flange <sup>1</sup>	A	EA	EB	ED	FF Ø
50	13	47	17.5	38.1	M8x1.25	13
63	13	55				
80	13	68				
100	19	80	22.2	47.6	M10x1.5	19
125	19	97				
140	25	121	26.2	52.4	M10x1.5	25
160	25	129				
180	25	152				
200	25	160				
250	32	201	30.2	58.7	M12x1.75 <sup>2</sup>	32
320	32	250				

Bore Ø	Oversize Flange Port					
	DN Flange <sup>1</sup>	A	EA	EB	ED	FF Ø
50	-	-	-	-	-	-
63	-	-	-	-	-	-
80	19	66	22.2	47.6	M10x1.5	19
100	25	79				
125	25	97	26.2	52.4	M10x1.5	25
140	32	120				
160	32	128				
180	32	151				
200	32	159	30.2	58.7	M12x1.75 <sup>2</sup>	32
250	38 <sup>3</sup>	197 <sup>3</sup>				
320	38 <sup>3</sup>	248 <sup>3</sup>				

<sup>1</sup> 25 bar to 350 bar series

<sup>2</sup> M10x1.5 to ISO 6162 (1994) optional

<sup>3</sup> 400 bar series



**Service Kits**

Service kits for MMA cylinders simplify the maintenance process and are supplied with full instructions. When ordering service kits, please refer to the identification plate on the cylinder body, and supply the following information:

Serial Number - Bore - Stroke - Model Number - Fluid Type

**Key to Part Numbers**

- 1 Head
- 7 Cap
- 14a Standard and Low Friction gland
- 14b Chevron gland
- 15 Cylinder tube
- 17 Piston
- 17a Chevron piston – head end
- 17b Chevron piston – cap end
- 18 Cushion sleeve
- 19 Front/rear flange
- 23 Head/cap securing screw
- 26 O-ring (cylinder body)
- 27 Gland retainer (secured by screws or threaded)

- 125 Standard piston seal
- 126 Energising ring for Standard seal 125
- 127 Wear ring for Standard piston
- 131 Low Friction piston seal
- 132 Energising ring for Low Friction piston seal 131
- 133 Wear ring for Low Friction piston
- 134 O-ring back up washer (gland/head)
- 136 Gland securing screw
- 137 Chevron rod seal assembly
- 138 Back up washer – Chevron rod seal assembly
- 139a Wear ring for Chevron gland
- 139b Wear rings for Chevron gland
- 140a Wear ring for Standard gland
- 140b Wear rings for Standard gland
- 141a Wear ring for Low Friction gland
- 141b Wear rings for Low Friction gland
- 142 Chevron piston bearing ring
- 143 Chevron piston seal assembly

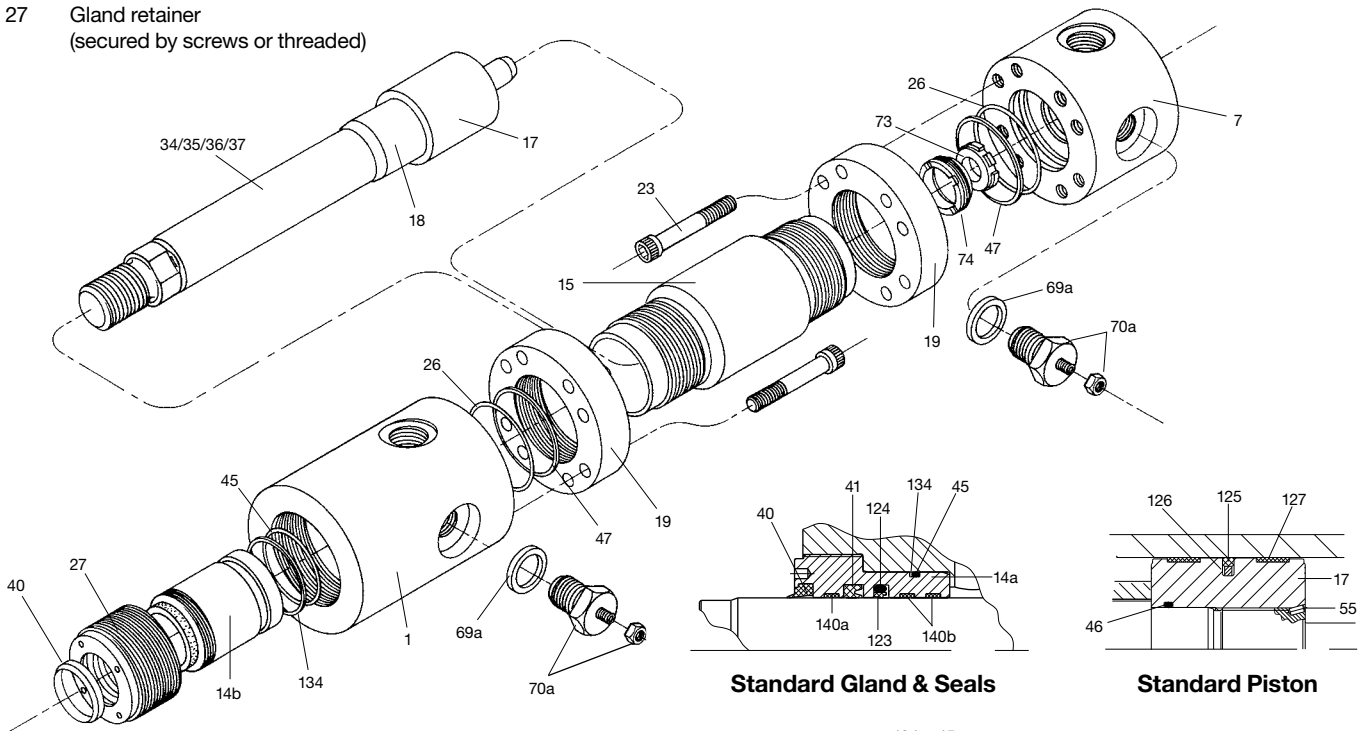

- 34 Piston rod – single rod, no cushion
- 35 Piston rod – single rod, cushion at head end
- 36 Piston rod – single rod, cushion at cap end
- 37 Piston rod – single rod, cushion at both ends
- 40 Gland wiperseal
- 41 Lipseal
- 45 O-ring (gland/head)
- 46 O-ring, piston/rod (2 off – chevron piston)
- 47 O-ring (cylinder body)
- 55 Piston locking pin
- 69a Cushion needle valve cartridge sealing washer
- 70a Cushion needle valve cartridge
- 73 Floating cushion bush
- 74 Cushion bush retaining ring
- 123 Stepseal
- 124 Pre-load ring for stepseal 123

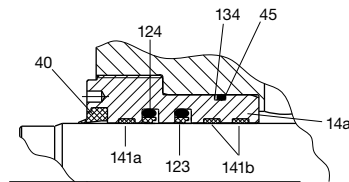

**Low Friction Gland & Seals**

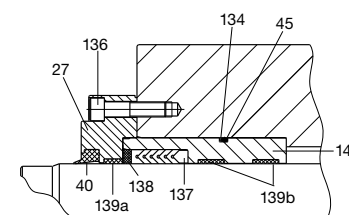

**Chevron Gland & Seals**

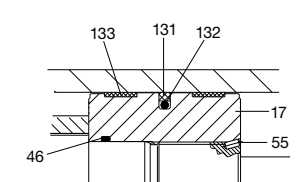

**Standard Piston**

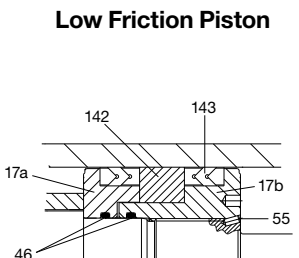

**Low Friction Piston**

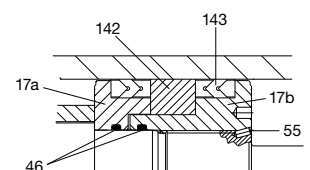

**Chevron Piston**

**Contents and Part Numbers of Service Kits**

**Gland Service Cartridge Kit** Contains items 14a, 40, 41, 45, 123, 124, 134, 140a, and two of 140b.

**Chevron Gland Service Cartridge Kit** Contains items 14b, 40, 45, 134, 137, 138, 139a, and two of 139b.

**Low Friction Gland Service Cartridge Kit** Contains items 14a, 40, 45, 134, 141a, and two each of 123, 124, 141b.

**Gland Service Kit** Contains items 40, 41, 45, 123, 124, 134, 140a, and two of 140b.

**Chevron Gland Service Kit** Contains items 40, 45, 134, 137, 138, 139a, and two of 139b.

**Low Friction Gland Service Kit** Contains items 40, 45, 134, 141a, and two each of 123, 124, 141b.

**Piston Service Kit, Standard Seals** Contains items 125, 126, and two of 26, 47 and 127.

**Piston Service Kit, Chevron Seals** Contains items 55, 142, and two each of 26, 46, 47 and 143.

**Piston Service Kit, Low Friction Seals** Contains items 131, 132, and two of 26, 47 and 133.

**Optional Seal Groups – Ordering**

The order codes listed for Chevron and Low Friction service kits contain standard, Group 1 seals. To order kits with other classes of seals, replace the last digit of the part number shown

with the number of the service group required.

Eg: RGF210MMA0701, containing a Group 1 seal, becomes RGF210MMA0705 when it contains a Group 5 seal.

**Repairs**

Although MMA cylinders are designed to make on site maintenance or repairs as easy as possible, some operations should only be carried out in our factory. It is standard policy to fit a cylinder returned to the factory for repair with those replacement parts which are necessary to return it to 'as good as new' condition. Should the condition of the returned cylinder be such that the expense would exceed the cost of a new one, you will be notified.

**Service Kit Order Codes – Piston and Body**

Bore Ø	Piston Service Kit, Standard Seals *	Piston Service Kit, Chevron Seals	Piston Service Kit, Low Friction Seals
50	PN050MMA01	PLL050MMA01	PF2050MMA01
63	PN063MMA01	PLL063MMA01	PF2063MMA01
80	PN080MMA01	PLL080MMA01	PF2080MMA01
100	PN100MMA01	PLL100MMA01	PF2100MMA01
125	PN125MMA01	PLL125MMA01	PF2125MMA01
140	PN140MMA01	PLL140MMA01	PF2140MMA01
160	PN160MMA01	PLL160MMA01	PF2160MMA01
180	PN180MMA01	PLL180MMA01	PF2180MMA01
200	PN200MMA01	PLL200MMA01	PF2200MMA01
250	PN250MMA01	PLL250MMA01	PF2250MMA01
320	PN320MMA01	PLL320MMA01	PF2320MMA01

**Service Kit Order Codes – Glands**

Bore Ø	Rod No.	Rod Ø	Gland Service Cartridge Kit *	Chevron Gland Service Cartridge Kit	Low Friction Gland Service Cartridge Kit	Gland Service Kit *	Chevron Gland Service Kit	Low Friction Gland Service Kit
50	1	32	RGN05MMA0321	RGLL05MMA0321	RGF205MMA0321	RKN05MMA0321	RKLL05MMA0321	RKF205MMA0321
	2	36	RGN05MMA0361	RGLL05MMA0361	RGF205MMA0361	RKN05MMA0361	RKLL05MMA0361	RKF205MMA0361
63	1	40	RGN06MMA0401	RGLL06MMA0401	RGF206MMA0401	RKN06MMA0401	RKLL06MMA0401	RKF206MMA0401
	2	45	RGN06MMA0451	RGLL06MMA0451	RGF206MMA0451	RKN06MMA0451	RKLL06MMA0451	RKF206MMA0451
80	1	50	RGN08MMA0501	RGLL08MMA0501	RGF208MMA0501	RKN08MMA0501	RKLL08MMA0501	RKF208MMA0501
	2	56	RGN08MMA0561	RGLL08MMA0561	RGF208MMA0561	RKN08MMA0561	RKLL08MMA0561	RKF208MMA0561
100	1	63	RGN10MMA0631	RGLL10MMA0631	RGF210MMA0631	RKN10MMA0631	RKLL10MMA0631	RKF210MMA0631
	2	70	RGN10MMA0701	RGLL10MMA0701	RGF210MMA0701	RKN10MMA0701	RKLL10MMA0701	RKF210MMA0701
125	1	80	RGN12MMA0801	RGLL12MMA0801	RGF212MMA0801	RKN12MMA0801	RKLL12MMA0801	RKF212MMA0801
	2	90	RGN12MMA0901	RGLL12MMA0901	RGF212MMA0901	RKN12MMA0901	RKLL12MMA0901	RKF212MMA0901
140	1	90	RGN14MMA0901	RGLL14MMA0901	RGF214MMA0901	RKN14MMA0901	RKLL14MMA0901	RKF214MMA0901
	2	100	RGN14MMA1001	RGLL14MMA1001	RGF214MMA1001	RKN14MMA1001	RKLL14MMA1001	RKF214MMA1001
160	1	100	RGN16MMA1001	RGLL16MMA1001	RGF216MMA1001	RKN16MMA1001	RKLL16MMA1001	RKF216MMA1001
	2	110	RGN16MMA1101	RGLL16MMA1101	RGF216MMA1101	RKN16MMA1101	RKLL16MMA1101	RKF216MMA1101
180	1	110	RGN18MMA1101	RGLL18MMA1101	RGF218MMA1101	RKN18MMA1101	RKLL18MMA1101	RKF218MMA1101
	2	125	RGN18MMA1251	RGLL18MMA1251	RGF218MMA1251	RKN18MMA1251	RKLL18MMA1251	RKF218MMA1251
200	1	125	RGN20MMA1251	RGLL20MMA1251	RGF220MMA1251	RKN20MMA1251	RKLL20MMA1251	RKF220MMA1251
	2	140	RGN20MMA1401	RGLL20MMA1401	RGF220MMA1401	RKN20MMA1401	RKLL20MMA1401	RKF220MMA1401
250	1	160	RGN25MMA1601	RGLL25MMA1601	RGF225MMA1601	RKN25MMA1601	RKLL25MMA1601	RKF225MMA1601
	2	180	RGN25MMA1801	RGLL25MMA1801	RGF225MMA1801	RKN25MMA1801	RKLL25MMA1801	RKF225MMA1801
320	1	200	RGN32MMA2001	RGLL32MMA2001	RGF232MMA2001	RKN32MMA2001	RKLL32MMA2001	RKF232MMA2001
	2	220	RGN32MMA2201	RGLL32MMA2201	RGF232MMA2201	RKN32MMA2201	RKLL32MMA2201	RKF232MMA2201

\* Only available with Group 1 Seals

All dimensions are in millimetres unless otherwise stated.



**How To Order**

'Mill Type' Cylinders

**MMA Series**

□	C	□	MMA	□	□	S	□	□	□	C	□	□	□	□
Bore		Mounting Style	Series	Ports	Gland and Piston Type	Special Features	Piston Rod Number	Piston Rod End	Rod Thread	Cushion Cap Pages 17-18	Net Stroke	Fluid Medium	Port Positions	Air Bleeds
	Cushion Head Page 14													

Code	Mounting Style	Page
MF3	Head Circular Flange	6
MF4	Cap Circular Flange	6
MP3	Cap Fixed Eye	7
MP5	Cap Fixed Eye with Spherical Bearing	7
MT4	Intermediate Trunnion	8
MS2	Foot Mounting	8

Code	Port Style	Page
R	BSP Parallel	16
M	Metric to DIN 3852 Pt. 1	16
Y	Metric to ISO 6149	16
P	Flange Ports to ISO 6162	16

Code	Gland & Piston Type	Page
N	Standard (Group 1 fluids only)	4
F	Low Friction	4
LL	Chevron	4
A	Load Holding (Group 1 fluids only)	4
E	Special designs	4

Code	Special Features	Page
S	Oversized Ports	16
S	Special Seals	4
S	Stop Tube – or to customer specification	13

Code	Fluid Medium	Page
M	Group 1	4
C	Group 2	4
D	Group 5	4
A1	Group 6	4
B	Group 7	4

Code	Port Position	Page
1	Head position 1-4	19
1	Cap position 1-4	19

Code	Air Bleed Position	Page
4	Head position 1-4	3, 19
4	Cap position 1-4	3, 19
00	No air bleeds	–

Code	Thread	Page
M	Metric (standard)	10

Code	Rod End Style	Page
4	Style 4	10
9	Style 9	10
3	Style 3 (Special) – please supply description or drawing	10

Code	Rod Number	Page
1	Rod No.1	6-8
2	Rod No.2	6-8

**Key**

Required for basic cylinder □

Indicate optional features or leave blank ◻

**Accessories**

Please state on order whether accessories are to be assembled to cylinder or supplied separately.

**Example**

50	C	MF3	MMA	R	N	S	1	9	M	C	230	M	11	44
----	---	-----	-----	---	---	---	---	---	---	---	-----	---	----	----

**Ports, Air Bleeds and Cushion**

**Adjustment Location**

As standard, port location is position 1, as shown on pages 6 to 8. Cushion adjustment needle valves, where specified, are at position 2.

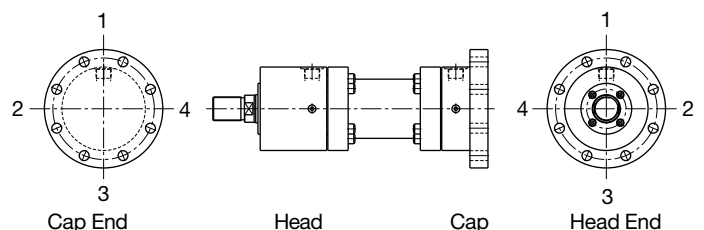

# Parker Worldwide

**AE – UAE**, Dubai  
Tel: +971 4 8127100  
parker.me@parker.com

**AR – Argentina**, Buenos Aires  
Tel: +54 3327 44 4129

**AT – Austria**, Wiener Neustadt  
Tel: +43 (0)2622 23501-0  
parker.austria@parker.com

**AT – Eastern Europe**,  
Wiener Neustadt  
Tel: +43 (0)2622 23501 970  
parker.easteurope@parker.com

**AU – Australia**, Castle Hill  
Tel: +61 (0)2-9634 7777

**AZ – Azerbaijan**, Baku  
Tel: +994 50 2233 458  
parker.azerbaijan@parker.com

**BE/LU – Belgium**, Nivelles  
Tel: +32 (0)67 280 900  
parker.belgium@parker.com

**BR – Brazil**, Cachoeirinha RS  
Tel: +55 51 3470 9144

**BY – Belarus**, Minsk  
Tel: +375 17 209 9399  
parker.belarus@parker.com

**CA – Canada**, Milton, Ontario  
Tel: +1 905 693 3000

**CH – Switzerland**, Etoy  
Tel: +41 (0) 21 821 02 30  
parker.switzerland@parker.com

**CN – China**, Shanghai  
Tel: +86 21 5031 2525

**CZ – Czech Republic**, Klecany  
Tel: +420 284 083 111  
parker.czechrepublic@parker.com

**DE – Germany**, Kaarst  
Tel: +49 (0)2131 4016 0  
parker.germany@parker.com

**DK – Denmark**, Ballerup  
Tel: +45 43 56 04 00  
parker.denmark@parker.com

**ES – Spain**, Madrid  
Tel: +34 902 33 00 01  
parker.spain@parker.com

**FI – Finland**, Vantaa  
Tel: +358 (0)20 753 2500  
parker.finland@parker.com

**FR – France**, Contamine s/Arve  
Tel: +33 (0)4 50 25 80 25  
parker.france@parker.com

**GR – Greece**, Athens  
Tel: +30 210 933 6450  
parker.greece@parker.com

**HK – Hong Kong**  
Tel: +852 2428 8008

**HU – Hungary**, Budapest  
Tel: +36 1 220 4155  
parker.hungary@parker.com

**IE – Ireland**, Dublin  
Tel: +353 (0)1 466 6370  
parker.ireland@parker.com

**IN – India**, Mumbai  
Tel: +91 22 6513 7081-85

**IT – Italy**, Corsico (MI)  
Tel: +39 02 45 19 21  
parker.italy@parker.com

**JP – Japan**, Fujisawa  
Tel: +(81) 4 6635 3050

**KR – South Korea**, Seoul  
Tel: +82 2 559 0400

**KZ – Kazakhstan**, Almaty  
Tel: +7 7272 505 800  
parker.easteurope@parker.com

**LV – Latvia**, Riga  
Tel: +371 6 745 2601  
parker.latvia@parker.com

**MX – Mexico**, Apodaca  
Tel: +52 81 8156 6000

**MY – Malaysia**, Subang Jaya  
Tel: +60 3 5638 1476

**NL – The Netherlands**,  
Oldenzaal  
Tel: +31 (0)541 585 000  
parker.nl@parker.com

**NO – Norway**, Ski  
Tel: +47 64 91 10 00  
parker.norway@parker.com

**NZ – New Zealand**, Mt Wellington  
Tel: +64 9 574 1744

**PL – Poland**, Warsaw  
Tel: +48 (0)22 573 24 00  
parker.poland@parker.com

**PT – Portugal**, Leca da Palmeira  
Tel: +351 22 999 7360  
parker.portugal@parker.com

**RO – Romania**, Bucharest  
Tel: +40 21 252 1382  
parker.romania@parker.com

**RU – Russia**, Moscow  
Tel: +7 495 645-2156  
parker.russia@parker.com

**SE – Sweden**, Spånga  
Tel: +46 (0)8 59 79 50 00  
parker.sweden@parker.com

**SG – Singapore**  
Tel: +65 6887 6300

**SK – Slovakia**, Banská Bystrica  
Tel: +421 484 162 252  
parker.slovakia@parker.com

**SL – Slovenia**, Novo Mesto  
Tel: +386 7 337 6650  
parker.slovenia@parker.com

**TH – Thailand**, Bangkok  
Tel: +662 717 8140

**TR – Turkey**, Istanbul  
Tel: +90 216 4997081  
parker.turkey@parker.com

**TW – Taiwan**, Taipei  
Tel: +886 2 2298 8987

**UA – Ukraine**, Kiev  
Tel: +380 44 494 2731  
parker.ukraine@parker.com

**UK – United Kingdom**,  
Warwick  
Tel: +44 (0)1926 317 878  
parker.uk@parker.com

**US – USA**, Cleveland  
(industrial)  
Tel: +1 216 896 3000

**US – USA**, Lincolnshire  
(mobile)  
Tel: +1 847 821 1500

**VE – Venezuela**, Caracas  
Tel: +58 212 238 5422

**ZA – South Africa**,  
Kempton Park  
Tel: +27 (0)11 961 0700  
parker.southafrica@parker.com

European Product Information Centre  
Free phone: 00 800 27 27 5374  
(from AT, BE, CH, CZ, DE, EE, ES, FI, FR, IE,  
IT, PT, SE, SK, UK)

